

4

3

2

1

F

F

A

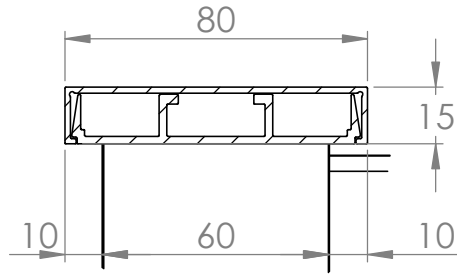

DÉTAIL A
ECHELLE 1 : 2

E

E

Réglage jusqu'à 20 mm avec les fixations



Tableau max 1750mm

D

D

1030

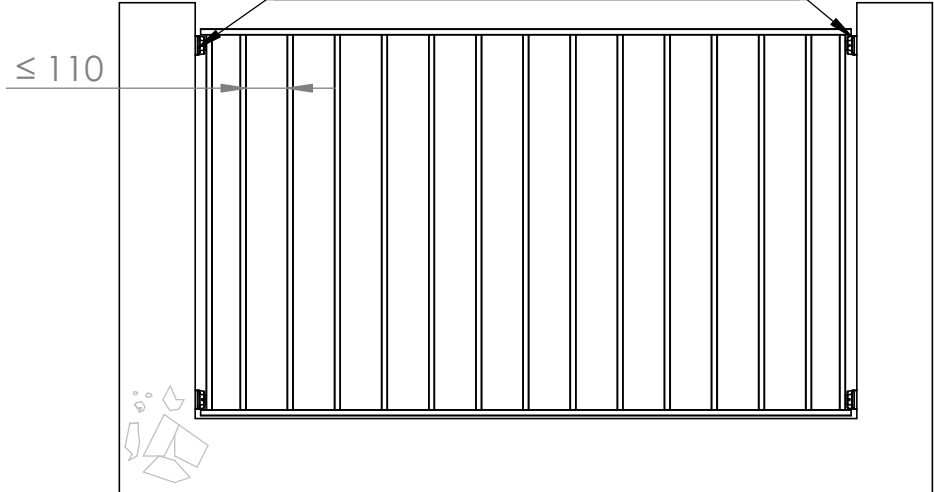
937

PROFIL
BARREAUDAGE

PROFIL RAIDISSEUR

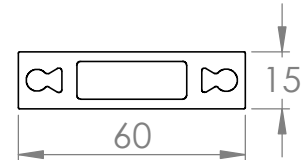
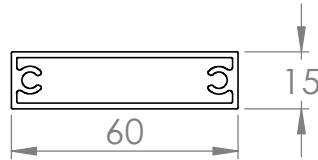

C

C

DÉTAILS DES FIXATIONS MURALE

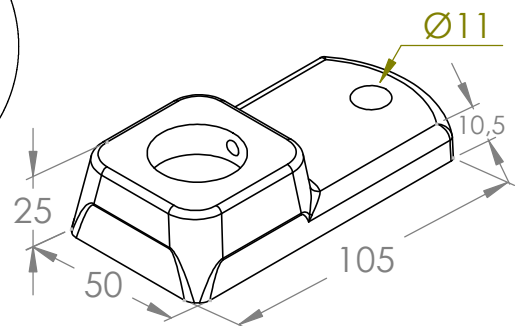
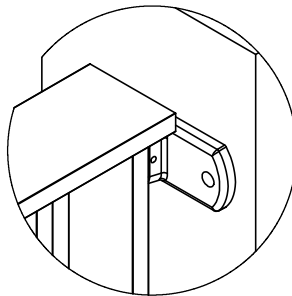

B

B

8

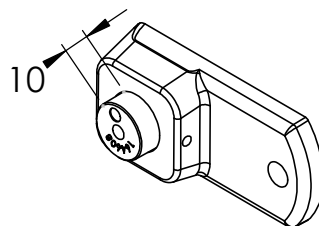

(Jeu possible de chaque
coté du tableau)

A

A

Goujons d'ancrages non fournis, mais
doivent être obligatoirement en inox

Modèle **KAPITALE** (pose tableau)

MAJUSKULE
GARDE-CORPS

LES CÔTES SONT EN mm

4

3

2

1